

(((Programmable Mechanical Cell Stretch System)))

ShellPa Pro



System Configuration



Main unit

Size : 290(W) x 300(D) x 120(H)mm (cover closed)
290(W) x 300(D) x 255(H)mm (cover open)

Weight : 6 kg



Controller

Size : 320(W) x 270(D) x 155(H)mm

Weight : 4kg

AC : IP 100-240V 47-63Hz, OP DC24V 2.5A (Max)



Stretch chamber

Stretch chamber specifications

The chamber has been developed specifically for the ShellPa series. Cells are observable through a transparent bottom membrane with a microscope. The chamber's high elasticity and restorative ability enable consistent experiments in ShellPa series.

Material: PDMS (Polydimethylsiloxane)
Area of base for culturing: 4 cm²

Need to be coated (e.g. with fibronectin, collagen) before culturing

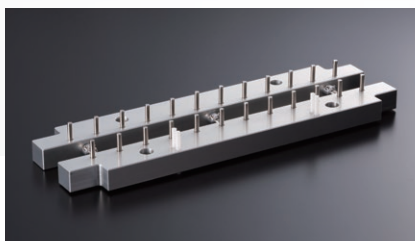
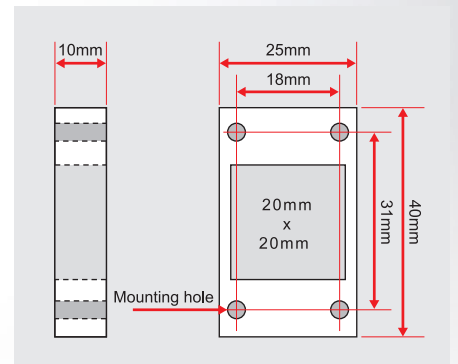

Chamber holder

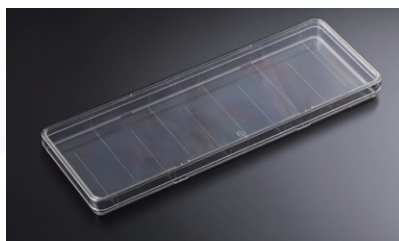

Accessory tray

Optional parts (not included)

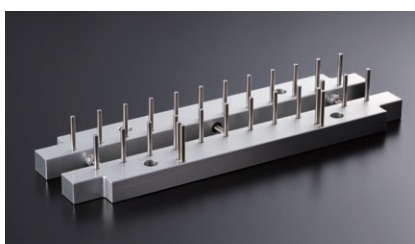

Double-chamber holder

Using the double-chamber holder, stretch culturing in up to 12 stretch chambers at a time can be performed under identical conditions.

What is

ShellPa Pro?



"ShellPa Pro" is a mechanical cell stretch system developed to replicate the dynamic environment inside the human body and to apply mechanical stress on cells being cultured outside the body. Changes and responses of cultured cells, not obtainable in conventional static cell culture, can be observed. "ShellPa Pro" in addition to the basic functions of "ShellPa", provides a greater variety of dynamic environments.

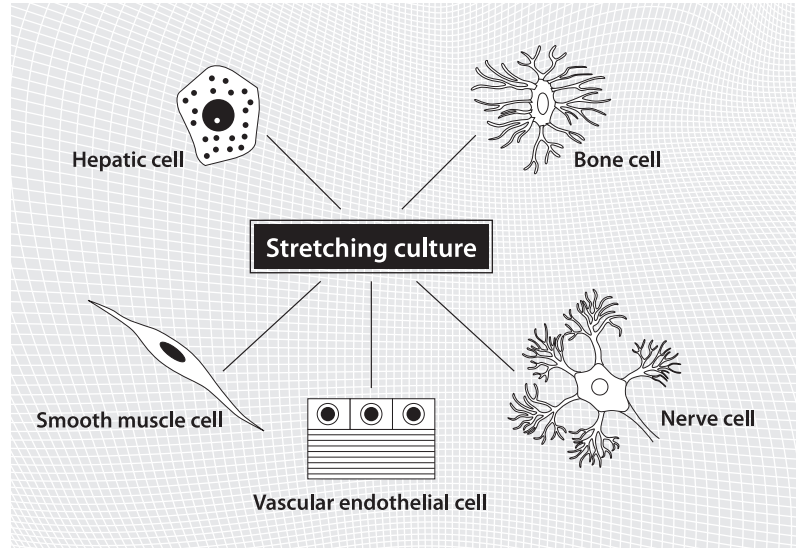

Product Features

(((1)))

Variety of stretch pattern setting available

- **Operating pattern**
Sine wave, Square wave, Triangle wave, Saw-tooth wave, etc.
- **Stretch velocity**
0.4 mm/min (1%) - 960 mm/min (20%)
- **Stretch ratio**
1-20% (in 1% steps)
- **Retention of stretching state**
Retention of stretching state and non-stretching state for 24 hours
- **Setting of continuous stretch frequency**
Automatic standstill at the end of the set frequency

(((2)))

Condition setting by functional touch panel

Easy condition setting using simple and functional touch panel of the controller.



(((3)))

Use of electronic motor with little heat generation

Using a motor with little heat generation to drive the stretch, it will not give a significant impact in the laboratory incubator.



For details of stretch wave patterns, see Figure 1: Operating Pattern.

Stretch Pattern

Program functions of "ShellPa Pro" enable setting of the stretch ratio, stretch velocity, stretch retention time, the number of the continuous stretch frequency, etc. A variety of mechanical stress can be applied to cells by modifying basic square and sine wave patterns. (See Figure 1 below)

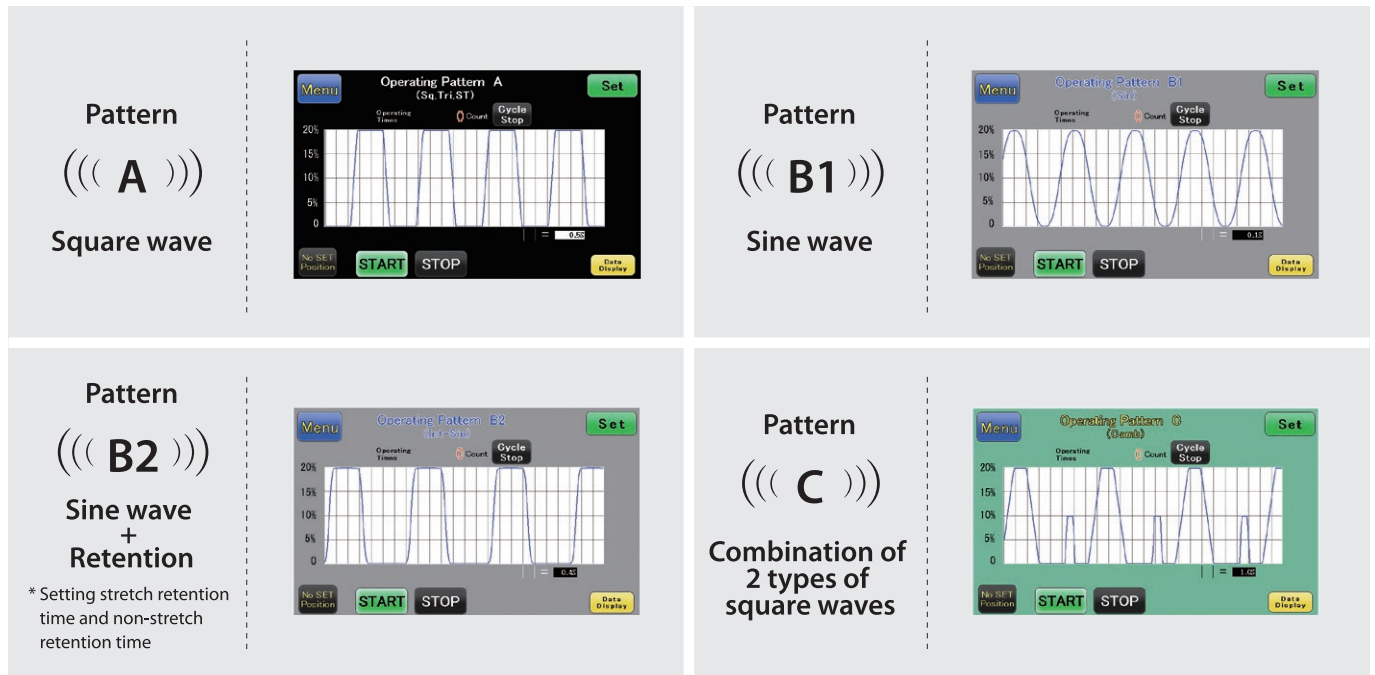
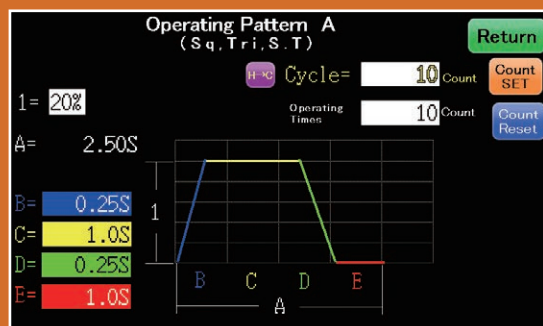

Figure 1. Operating Pattern (showing reference wave patterns)

How to enter the Operating Pattern

Set the stretch conditions by entering each parameter (1, B, C, D, E) on the touch panel screen in Figure 2 below.



1: Stretch ratio (%)

A : Stretch frequency (A = B + C + D + E)

B : Time required to reach the longest stretch (Slope: Stretch velocity)

C : Retention time in the longest stretch state

D : Restoration time required to reach a non-stretching state (Slope: Restorative velocity)

E : Time for static cell culturing (Retention time in non-stretching state)

Cycle : Number of continuous stretch frequency

Set the number of operations before the automatic standstill in multiples of the stretch frequency (A).

Figure 2. Example of entering the Operating Pattern (Pattern A)

Operation

- ① Seed and culture cells in the stretch chambers.
- ② Turn on the controller, select the basic pattern (square wave, sine wave) on the touch screen, and set the stretch conditions (stretch ratio, stretch velocity, stretch retention time, etc.).
- ③ Place the stretch chambers onto the chamber holder.
- ④ Place the chamber holder into the main unit.
- ⑤ Press the start switch (touch switch) on the controller to start stretching culture.



Practical Examples

Stretching culture of Human Umbilical Vein Endothelial Cells (HUVEC)

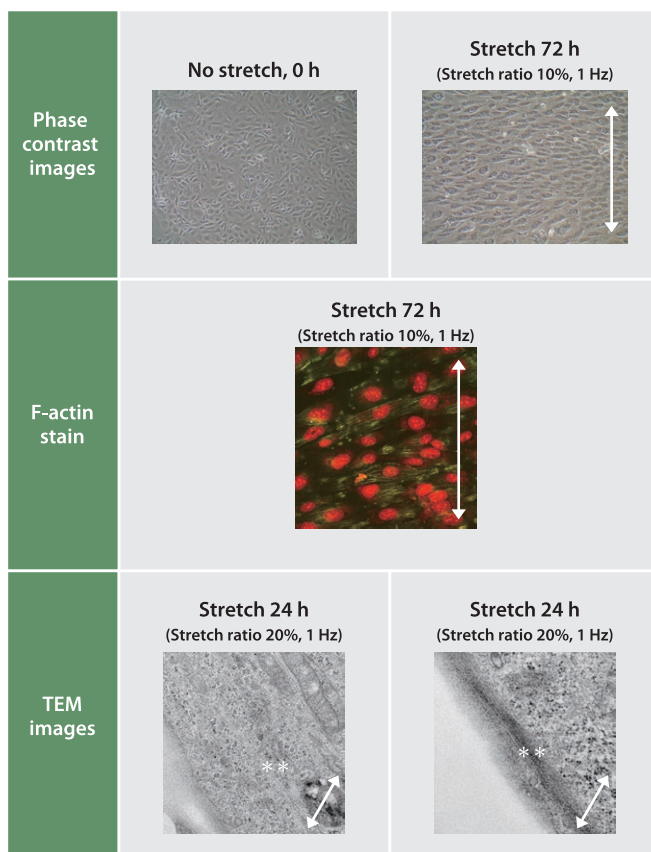

Stretching culture of HUVEC for 24-72 hours caused an alignment of cells perpendicular to the direction of stretching (top right) by using ShellPa Pro (stretch ratio 10%, 1Hz). Expression of stress fiber F-actin (green stain, middle left, middle right) was also observed. Transmission electron microscopy showed expressions of actin fiber perpendicular to the direction of stretching (twin asterisks at bottom left) and stress fiber by assembling of action fiber (twin asterisks at bottom right). White arrows show the direction of stretch.

Stretching culture of Murine myoblast cell line (C2C12 cells)

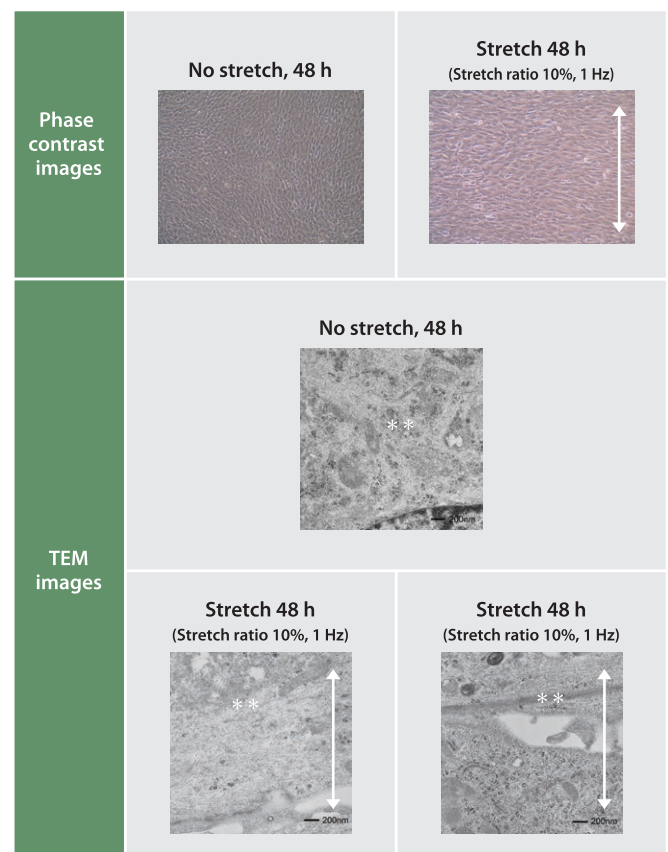

Stretching culture of C2C12 cells for 24-48 hours caused an alignment of cells perpendicular to the direction of stretching (top right) by using ShellPa Pro (stretch ratio 10%, 1Hz). Transmission electron microscopy of C2C12 cells without stretching showed expression of randomly arranged actin fiber (middle left, middle right). Stretching culture of C2C12 cells for 48 hours caused expressions of actin fiber perpendicular to the direction of stretching (bottom left) and stress fiber by assembling of actin fiber (bottom right). White arrows show the direction of stretch.

Product Specifications

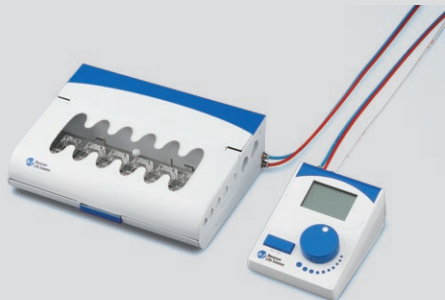
	ShellPa Pro	ShellPa
System image		
Size (main unit)	290(W) X 300(D) X 120(H) mm	270(W) X 210(D) X 93(H) mm
Weight (main unit)	6kg	3kg
Drive system	Electric motor	Compressor
Stretch ratio	1–20% (in 1% steps)	2,4,5,6,8,10,12,15,20%
Frequency	1/60–2Hz	1/60–2Hz
Stretch velocity	0.4 mm/min (1%) ~ 960 mm/min (20%)	Constant (low-velocity unavailable)
Stretch wave pattern	Sine wave, Square wave, Triangle wave, Saw-tooth wave, and combination of two types of Square waves	Square wave, Triangle wave
Stretch retention	0 sec–24h	Linked to frequency Max. 30 sec. at 1/60 Hz
Timer Function (Automatic standstill)	Set the repetition number of the continuous stretch frequency	Set cyclic stretch-standstill time in 10 min. and the repetition number of times (1–100 times)
No. of mounting chambers	6 (Optional, max. 12)	max. 6
Power supply adapter	IP 100-240V 47-63Hz OP DC24V 2.5A (max)	IP 100-240V 50/60Hz OP DC12V 1A (max)

Menicon Co., Ltd. Life Science Department

Miyuki Business Park Bldg. #4, 390 Ichibagi-cho, Nishi-ku, Nagoya, Aichi 452-0805, Japan
 Phone: +81-52-325-7385 Fax: +81-52-325-7386
 Email: info@menicon-lifescience.com
 Web: <https://www.menicon-lifescience.com/english/>